

erluna

elia
origin natural

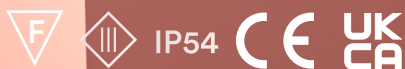

Diffuser - 15.8mm / 0.62in

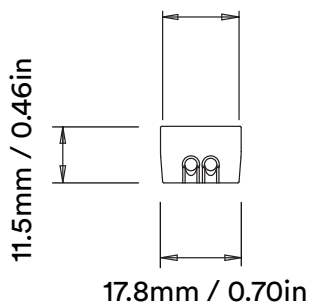

Fixing Clip 6mm / 0.3in

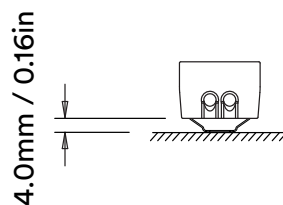
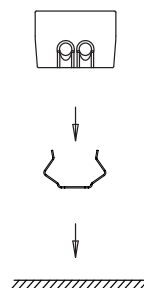
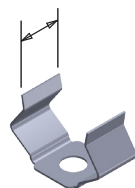

Fully assembled bespoke lengths and kit option
7.14mm LED pitch, no spotting
available in 10mm / 0.4in increments upto
2000mm / 78.7in. Sealed unit includes end caps,
clips and 500mm / 18.7in standard cable.

| | | 2700K | 3000K |
|--------------|------------------|---------|---------|
| LIGHT VALUES | | SOFT | SOFT |
| | LED Lumens | 1001 /m | 1082 /m |
| | Luminaire Lumens | 692 /m | 746 /m |
| | LED lm/W | 104 | 113 |
| | Luminaire lm /W | 72 | 78 |
| POWER | Voltage | 24VDC | 24VDC |
| | LED Power (typ) | 9.6W/m | 9.6W/m |
| | PCB Increments | 50mm | 50mm |

| | | |
|---------|-----------------------|---|
| BINNING | SDCM (Hot) | 3 |
| | CRI (typ)(R9) | 98 (99) |
| | TM30 Rf Rg | Rf 97.7 Rg 100.4 |
| | Lifetime (TM21) | L90 B5 50,000hrs (inc driver) |
| | Lifetime (Calculated) | L70 120,000hrs |
| DRIVER | Protocols | Non-Dim / Mains Dim / DALI / 0-10V |
| | Dim to Dark | 0.1% Lux |
| | Distance from LED | 20m / 65' (From driver to end of LED strip) |
| | Emergency | Emergency packs not available |

| 9.6W/M LED STRIP (50mm PCB increments) | | | | |
|--|-------------|-------------|----------------------|------------------------|
| | ORDER CODE | MIN WATTAGE | MAX WATTAGE | |
| DRIVER OPTIONS | Non-dim 20W | LN20 | 2W (200mm LED strip) | 20W (2000mm LED strip) |
| | Mains 30W | LM30 | 3W (300mm LED strip) | 30W (3000mm LED strip) |
| | Mains 90W | LM90 | 9W (900mm LED strip) | 90W (9000mm LED strip) |
| | DALI 50W | LD50 | 1W (100mm LED strip) | 50W (5000mm LED strip) |
| | DALI 80W | LD80 | 1W (100mm LED strip) | 80W (8000mm LED strip) |
| | 1-10V 20W | L020 | 1W (100mm LED strip) | 20W (2000mm LED strip) |
| | 1-10V 60W | L060 | 1W (100mm LED strip) | 60W (6000mm LED strip) |

HOW TO ORDER

BESPOKE LENGTHS - code: ELI - Fully assembled bespoke lengths available in 10mm increments, up to 2000mm. Sealed unit includes end caps, clips and 500mm standard cable. Minimum bespoke length 100mm.

KIT OPTION - code: ELK - Order any length required in 50mm increments. Separate components supplied and assembled on site. Profile supplied in 2000mm lengths max. Kit includes per 1000mm order: Profile, diffuser, LED strip, two end caps, two fixing clips and 100mm of cable. Must be assembled on site.

Note: LED strip can be cut on site every 50mm

SPECIFICATION CODE

| Engine type | Extrusion | Colour Temp | Driver | Beam Width | Extrusion Colour | Options |
|-------------|---------------------------------|---|---------------|------------|--|----------------------------|
| NL | - ELI | - 27 | X | W | - W | - 54 |
| | ELI / Bespoke ELK / Kit form | 27 / 2700K 30 / 3000K 40 / 4000K* | X / No Driver | W / Wash | W / White 9010*1 C / Other RAL*2 | 54 / IP64 Y5 / 5m Cable |
| | | *NOTE: increase 3000K by 7% | | | *1 - standard, in stock *2 - premium, non-stock | |

COMPONENT PART CODES

| | |
|---|-------------------|
| Additional end cap with cable entry: | ENDCAP/ELI/OPEN |
| Additional end cap without cable entry: | ENDCAP/ELI/CLOSED |
| Additional fixing clip: | FIX/ELI |

Installation

multiple lengths

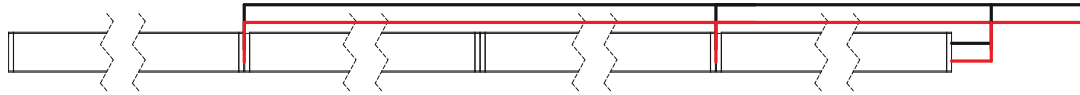

**When joining multiple lengths together butt up ends
and run the cables to one side connecting the feeds in parallel**

overlapping lengths

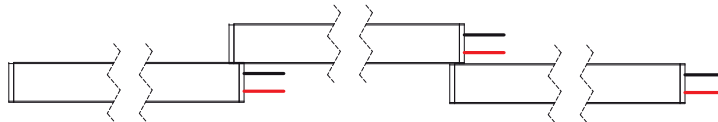

Long lengths can also be created by overlapping lengths

corner joints

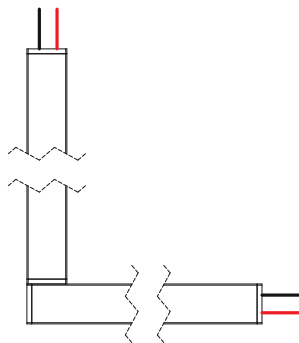

**When joining corner position so that
powered ends are away for the mating ends**

curved sections

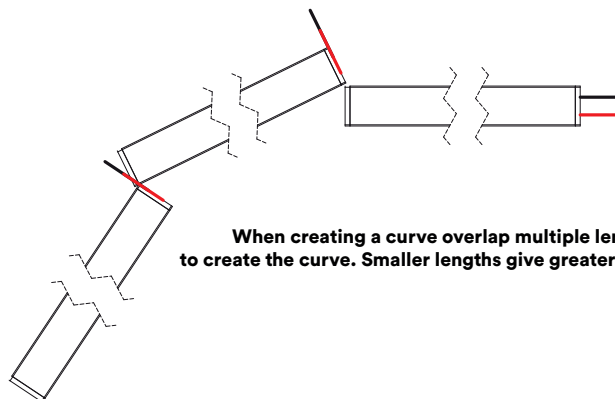

**When creating a curve overlap multiple lengths
to create the curve. Smaller lengths give greater curvature**



Wiring details

Individual Lengths

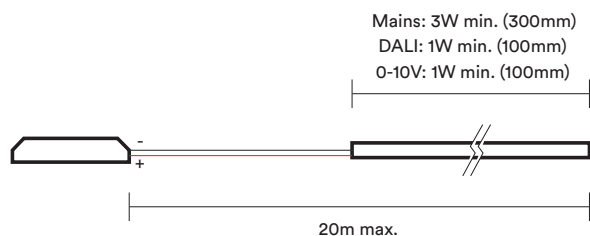

Multiple Lengths

Wired in parallel

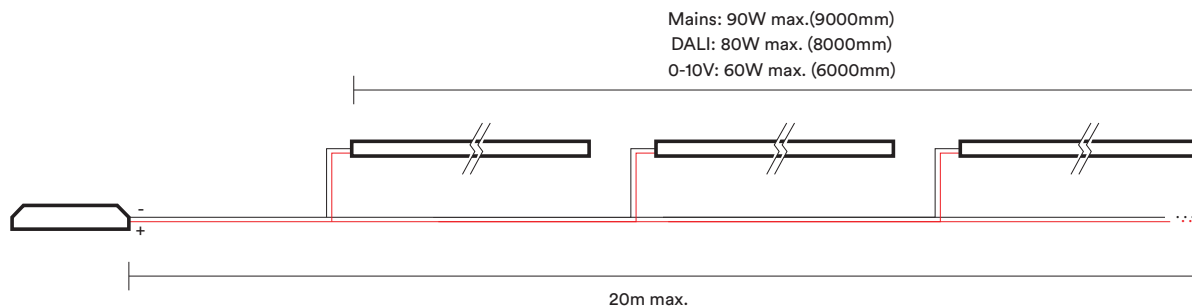

Recommended lengths for best lit effect



DALI and 1-10V:
110mm (min) to 2010mm (max) in 50mm increments
Non-dim:
210mm (min) to 2010mm (max) in 50mm increments
Mains dim:
310mm (min) to 2010mm (max) in 50mm increments

INSTALLATION

- Ensure mounting surface is level before installing.
- Fixing brackets screwed into place and the profile clipped on. 2 fixing brackets per metre.
- Only to be installed by a qualified electrician.
- Disconnect the unit from mains power before installing or servicing.
- Do not exceed the products specified power rating.
- Installation must be carried out in accordance with national and local standards.
- Ensure the correct polarity is maintained when wiring. If in any doubt contact orluna.
- Unauthorised repairs or modifications will void warranty.