

Diffuser - 11.2mm / 0.44in

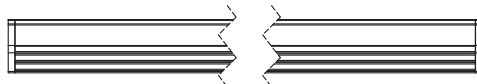

Fixing clip - 20mm / 0.79in

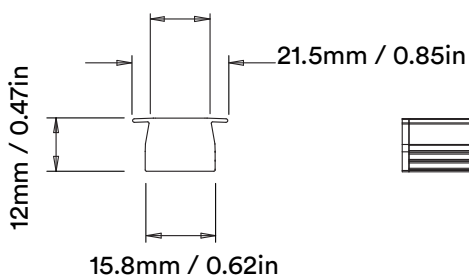
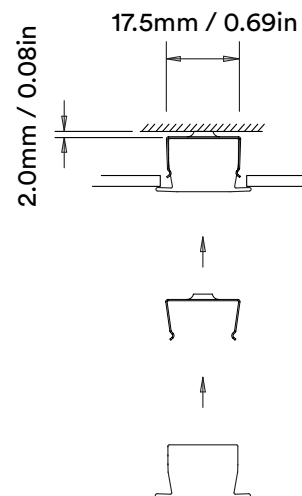
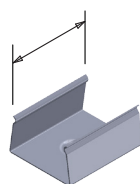

Fully assembled bespoke lengths and kit option
7.14mm LED pitch, no spotting
available in 10mm / 0.4in increments upto
2000mm / 78.7in. Sealed unit includes end caps,
clips and 500mm / 18.7in standard cable.



		2700K	3000K
LIGHT VALUES		SOFT	SOFT
	LED Lumens	1001 /m	1082 /m
	Luminaire Lumens	579 /m	625 /m
	LED lm/W	104	113
POWER	Luminaire lm /W	60	65
	Voltage	24VDC	24VDC
	LED Power (typ)	9.4W/m	9.4W/m
	PCB Increments	50mm	50mm

BINNING	SDCM (Hot)	3
	CRI (typ)(R9)	98 (99)
DRIVER	TM30 Rf Rg	Rf 97.7 Rg 100.4
	Lifetime (TM21)	L90 B5 50,000hrs (inc driver)
	Lifetime (Calculated)	L70 120,000hrs
DRIVER	Protocols	Non-Dim / Mains Dim / DALI / 0-10V
	Dim to Dark	0.1% Lux
	Distance from LED	20m / 65' (From driver to end of LED strip)
	Emergency	Emergency packs not available

9.6W/M LED STRIP (50mm PCB increments)				
	ORDER CODE	MIN WATTAGE	MAX WATTAGE	
DRIVER OPTIONS	Non-dim 20W	LN20	2W (200mm LED strip)	20W (2000mm LED strip)
	Mains 30W	LM30	3W (300mm LED strip)	30W (3000mm LED strip)
	Mains 90W	LM90	9W (900mm LED strip)	90W (9000mm LED strip)
	DALI 50W	LD50	1W (100mm LED strip)	50W (5000mm LED strip)
	DALI 80W	LD80	1W (100mm LED strip)	80W (8000mm LED strip)
	1-10V 20W	L020	1W (100mm LED strip)	20W (2000mm LED strip)
	1-10V 60W	L060	1W (100mm LED strip)	60W (6000mm LED strip)

HOW TO ORDER

BESPOKE LENGTHS - code: ART - Fully assembled bespoke lengths available in 10mm increments, up to 2000mm. Sealed unit includes end caps, clips and 500mm standard cable. Minimum bespoke length 100mm.

KIT OPTION - code: ARK - Order any length required in 50mm increments. Separate components supplied and assembled on site. Profile supplied in 2000mm lengths max. Kit includes per 1000mm order: Profile, diffuser, LED strip, two end caps, two fixing clips and 100mm of cable. Must be assembled on site.

Note: LED strip can be cut on site every 50mm

SPECIFICATION CODE

Engine type	Extrusion	Colour Temp	Driver	Beam Width	Extrusion Colour	Options
NL	- ART -	27	X	W	- W -	54
	ART / Bespoke ARK / Kit form	27 / 2700K 30 / 3000K 40 / 4000K*	X / No Driver	W / Wash	W / White 9010*1 C / Other RAL*2	54 / IP64 Y5 / 5m Cable
		*NOTE: increase 3000K by 7%			*1 - standard, in stock *2 - premium, non-stock	

COMPONENT PART CODES

Additional end cap with cable entry:	ENDCAP/ART/OPEN
Additional end cap without cable entry:	ENDCAP/ART/CLOSED
Additional fixing clip:	FIX/ART

Installation

multiple lengths

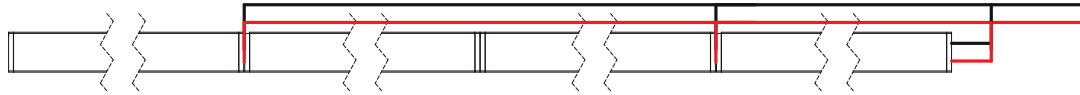

**When joining multiple lengths together butt up ends
and run the cables to one side connecting the feeds in parallel**

overlapping lengths

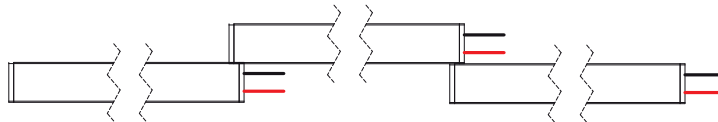

Long lengths can also be created by overlapping lengths

corner joints

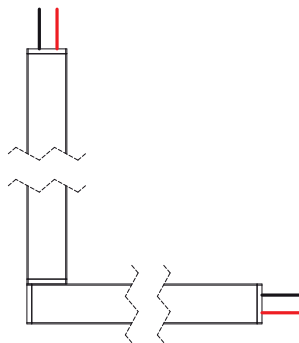

**When joining corner position so that
powered ends are away for the mating ends**

curved sections

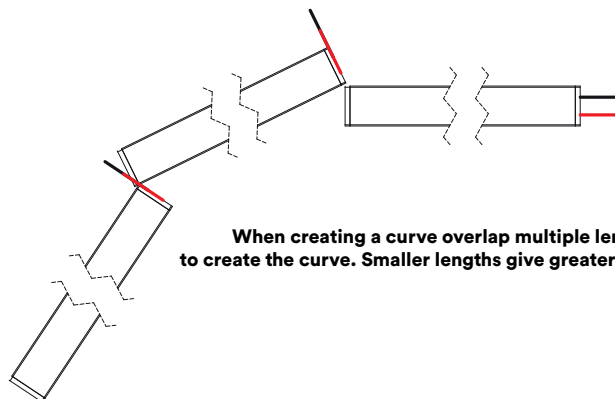

**When creating a curve overlap multiple lengths
to create the curve. Smaller lengths give greater curvature**



Wiring details

Individual Lengths

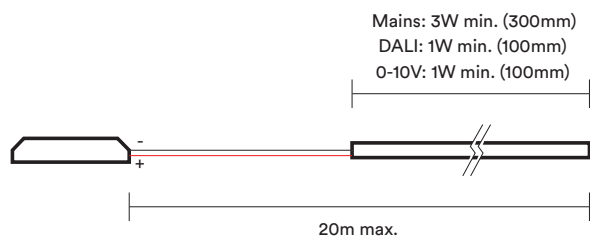

Multiple Lengths

Wired in parallel

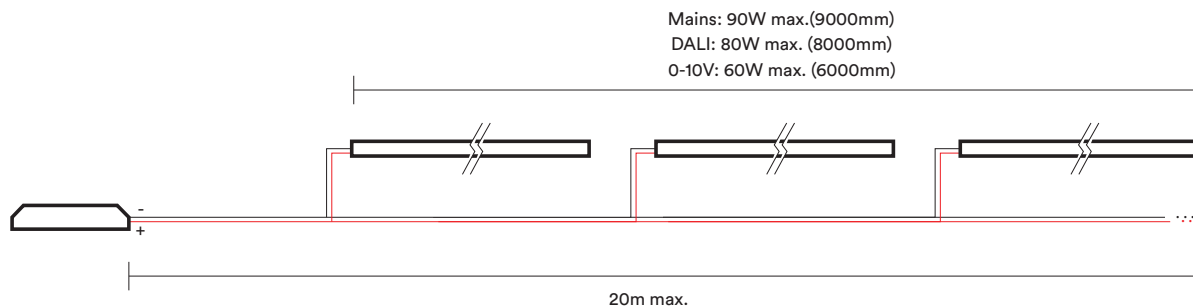

Recommended lengths for best lit effect

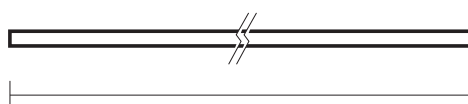

DALI and 1-10V:
130mm (min) to 2030mm (max) in 50mm increments
Non-dim:
230mm (min) to 2030mm (max) in 50mm increments
Mains dim:
330mm (min) to 2030mm (max) in 50mm increments

INSTALLATION

- Ensure mounting surface is level before installing.
- Fixing brackets screwed into place and the profile clipped on. 2 fixing brackets per metre.
- Only to be installed by a qualified electrician.
- Disconnect the unit from mains power before installing or servicing.
- Do not exceed the products specified power rating.
- Installation must be carried out in accordance with national and local standards.
- Ensure the correct polarity is maintained when wiring. If in any doubt contact orluna.
- Unauthorised repairs or modifications will void warranty.